

## Double Sheet Control System I100

Dual head double sheet detection system  
for ferrous and nonferrous materials

- Dual head sensors (transmitter / receiver), inductive
- Non-contact double sheet control of
  - Ferrous-material 0.05 - 4 mm (0.02 - 0.16 in) (single sheet)
  - Non-ferrous-material 0.05 - 12 mm (0.02 - 0.50 in) (single sheet)
- Suitable for fluttering sheets
- Easy set-up by key operation or via control input
- LCD display for visualization of nominal / current values, operational / error message, key allocation
- Compact enclosures
  - Control unit for DIN-rail mounting, protection class IP00
  - Control unit for machine frame mounting in protective enclosure, protection class IP54

### THE ROLAND PLUS

- ▶ Teach-In
- ▶ Clear-Type-Display
- ▶ 3 Outputs

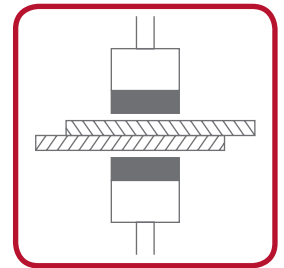

### The manual contains detailed security instructions

These devices are **NOT** suitable for personnel safety applications.  
Never use these products as sensing devices for personnel protection.  
Their use as a safety device may create an unsafe condition which could lead to injury or death.



## Application

When feeding sheets automatically, more than one sheet can be inadvertently fed into the processing machine. This can result in damage of the machine and tools, expensive repairs and production loss.

The dual head Double Sheet Detector I100 has been designed to prevent such events.

## Sensor mounting

The sensors can be installed in any position: horizontally or vertically. Transmitter and receiver must be aligned to each other "face-to-face".

- Preferably, sensors should „stick out“ when mounted in steel brackets.
- Use plastic brackets for flush mounting.
- Recessed mounting of the sensors is not recommended, because dirt and chippings can collect on the sensor surface.
- Brackets made of electrically highly conductive metals (e.g. aluminum, copper, brass), should not be used, because they degrade the sensor performance.

## Measurement principle

The system functions according to the transmission principle. The transmitter emits an alternating electrical field, the receiver on the other side of the sheet electronically detects the signal attenuated by the sheet. The receiver signal is processed in the control unit and made available to the machine control as switching signals.

## Sensor diagrams

The measurement range depends on the sensor gap ( $A_x$ ) and the type of material: ferrous (FE) or non-ferrous.

The shaded areas designate the working range of  $A_x$  for a particular type of material and sheet thickness; respectively the maximum and minimum sheet thickness to be controlled of a particular material for a given transmitter / receiver distance  $A_x$ .

The designated values are standard values, variations are possible due to material differences and installations of the sensors. Special sensor types, e.g. for special materials, can be delivered on request.

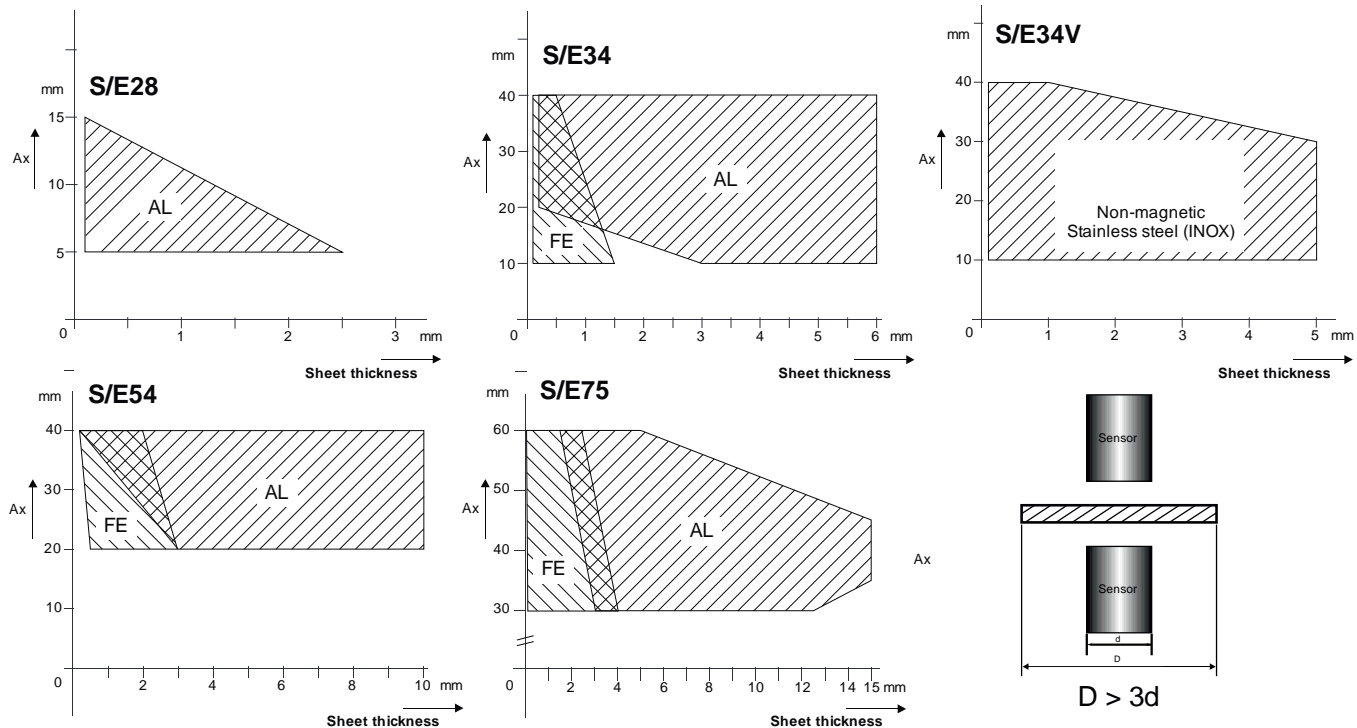

## Measurement target

Length and width of the sheet to be monitored should be at least 3 times the sensor diameter. In this case reliable double sheet control according to the conditions sketched out in the figure above is provided.

## Measurement time

The measurement time depends on the sensor diameter. The minimum dwell time is approximately equal to the sensor diameter in milliseconds (ms). The interval between two measurement cycles and the switching of the respective output is about the same as the minimum dwell time.

## Technical Data

I100		
Supply voltage	24 VDC (+6V / - 4V) / 110 mA	
Power consumption	approx. 2.7 W @ 24V	
Fuse	375 mA / slow-blow / size 5 x 20 mm	
Power / Switching indication	5 LEDs	
Display	LCD display, 16 characters each	
Ambient temperature	0° - 50°C (32° - 122°F) during operation	
Switching outputs 0-1-2 - Sheet	Opto coupler outputs, output sourcing (PNP)	
Temperature drift of switching point	± 0.02% / °C	
Switching capacity	max. 30 V, max 10 mA	
Measurement period	Depending on the sensor	
Enclosure	I100	For DIN-rail mounting (EN50022, BS5584)
	I100-S	For machine frame mounting
Class of protection	I100	IP 00
	I100-S	IP 54
Weight	I100	approx. 0.2 kg (0.44 lbs)
	I100-S	approx. 0.6 kg (1.32 lbs)
Connections	I100 / I100-S Terminal Block / Plug connection	
Dimensions	I100 / I100-S 125.4 x 103 x 46.5 / 130 x 155 x 37mm (H x W x D)	

## Dimensions

### I100

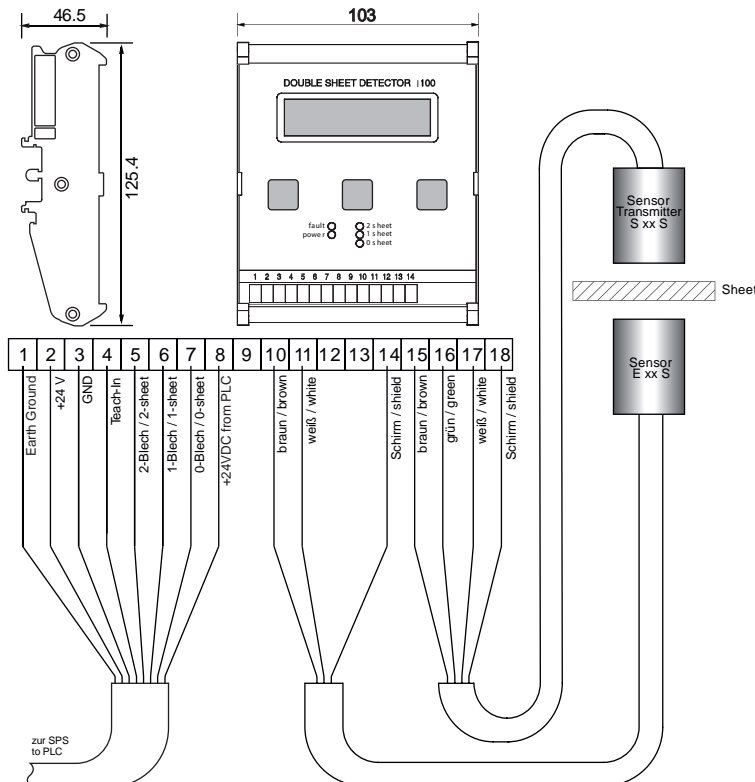

### I100-S

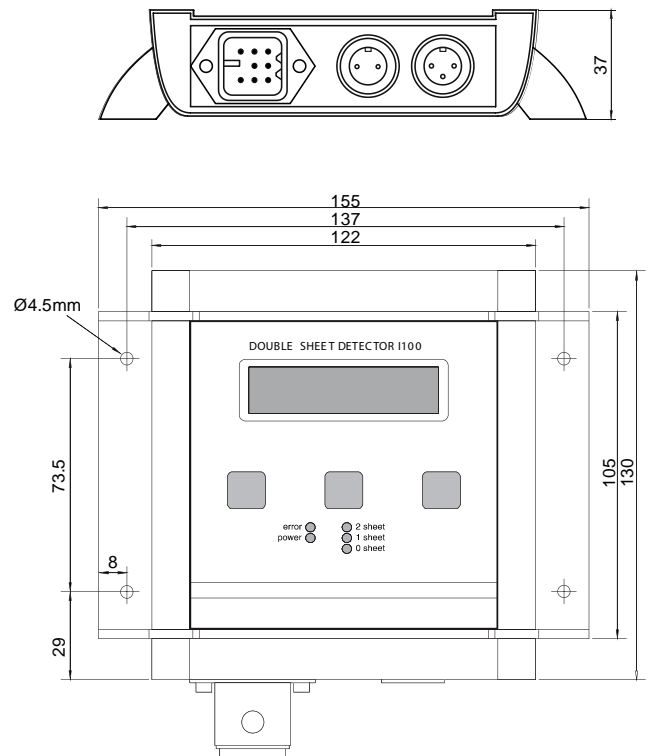

## Sensors

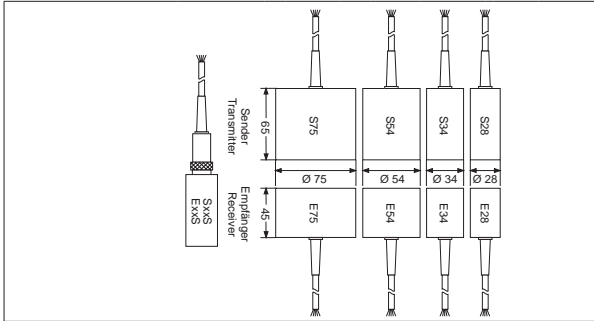

## Sensor data

Pair of sensors, with fixed cable	<b>S/E28</b>	<b>S/E34</b>	<b>S/E54</b>	<b>S/E75</b>	
Pair of sensors, with connecting socket	<b>S/E28S</b>	<b>S/E34S</b>	<b>S/E54S</b>	<b>S/E75S</b>	
Single sheet thickness	Corresponding to the sensor diagrams				
Switching time	30	35	55	75	ms
Diameter	28	34	54	75	mm
Length	Transmitter: 65 / Receiver: 45			mm	
Sensor weight approx.	0.15	0.32	0.38	1.1	kg
Ambient temperature	0° - 50°C in operation				
Class of protection	IP 65				

## Cable

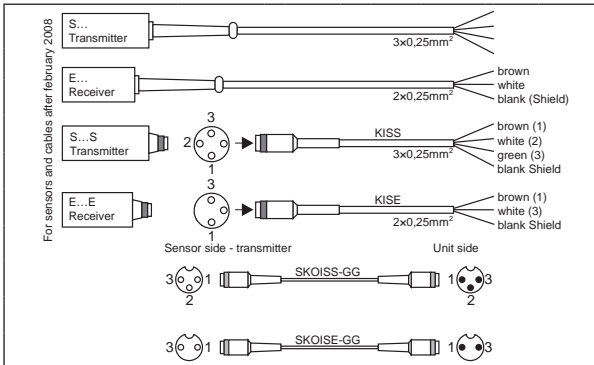

S0003515

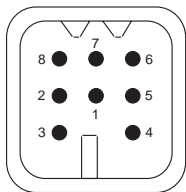

Enclosure HAN 3A, EMI-Type, metrical 7-pin insert and PE

Pin 1	+24VDC	Pin 5	1-sheet
Pin 2	GND	Pin 6	0-sheet
Pin 3	Teach-In	Pin 7	+24VDC from PLC
Pin 4	2-sheet	Pin 8	Earth Ground

## Abbreviated Set-up / Teach-In instructions

For detailed instructions refer to the Operating Manual  
**Teach-In instructions**

1. Set the sensor distance (Ax) according to the statements in the sensor diagrams.
2. Put a sheet with nominal thickness fully into the gap between the sensors.  
(see connection sketch)
3. Press the SETUP key and then the NEW key, a new Teach-In procedure will then be performed.
4. The green LED (1-SHEET) lights up now, the measuring value is stored.
5. Functional check:  
If a second sheet is placed into the sensor gap (double sheet condition), the red LED (2-SHEET) lights up. If both sheets are removed, the red LED (0-SHEET) lights up.

## ORDER INFORMATION

### Control Unit

Part name	Comment
<b>I100</b>	Control unit, for dual head sensor arrangements, operating voltage 24VDC.
<b>I100-S</b>	

### Sensors

Part name	Comment
<b>S/E28</b>	Pairs of sensors, fixed cable with open wire ends for terminal block wiring. Standard cable length is 2 meters, lengths up to 20 meters made to order.
<b>S/E34</b>	
<b>S/E34V_16kHz</b>	
<b>S/E54</b>	
<b>S/E75</b>	
<b>S/E34S</b>	Pairs of sensors, with terminal plug for connecting the sensor cable (please order cable separately).
<b>S/E34VS_16kHz</b>	
<b>S/E54S</b>	
<b>S/E75S</b>	
<b>S/E28S</b>	

S = Transmitter, E = Receiver,  
V = for Stainless Steel

### Cables\* (for pluggable sensors)

Part name	Comment
<b>KISS-G</b>	For connection of the transmitter
<b>KISE-G</b>	For connection of the receiver
<b>SKOISS-GG</b>	For connection for transmitter to the I100-S
<b>SKOISE-GG</b>	For connection for receiver to the I100-S

### Accessories (for I100-S)

Part name	Comment
S0003515	Supply plug set, complete
S0003517	Plug set, for sensor cables with open wire ends

\* Standard length of cables is 2m, lengths up to 20m upon order, larger lengths upon request.

